

## BLITZMATIC+

THE NEW PACKAGING MACHINE FOR 100% CARDBOARD OR GRASSPAPER LID APPLICATION



DE

### Foodtainer-Deckelmaschine (Deckel in Karton/Graspapier)

- **Leistung:** bis zu 45 Packungen/min
- **Integrierfähig/kompatibel** mit bestehenden Dosier- und Füllmaschinen/Jollypack
- Doppelkopf **Plug & Play** Deckelspender – **vollautomatisch und variabel** je nach Deckel/Foodtainergröße
- **Anpassungsfähige** Deckelapplikation für unterschiedliche Kalibrierungen der Früchte/Gemüsearten und unterschiedliche Foodtainer
- **Schalenformat min.**  
(L x B x H mm) 120 x 120 x 40
- **Schalenformat max.**  
(L x B x H mm) 260 x 130 x 40

IT

### Coperchiatrice (coperchi in cartone/carta erba)

- **Velocità:** fino a 45 confezioni/min
- **Compatibile** con sistemi di dosaggio e riempimento preesistenti/Jollypack
- Dispenser **automatico e variabile** in base al tipo di coperchio/dimensione vassoio - applicazione con tecnica **Plug & Play** a doppia testata
- Applicazione **flessibile** del coperchio adeguandosi alla dimensione della frutta/verdura
- **Formato vassoi min.**  
(L x l x H mm) 120 x 120 x 40
- **Formato vassoi max.**  
(L x l x H mm) 260 x 130 x 40

EN

### Foodtainer lid application machine (cover/lid in cardboard/grass paper)

- **Speed:** up to 45 packages/min
- **Compatible** with existing Filling Machines/Jollypack
- Double pickup-head with **Plug & Play** technology - Lid dispenser **adjustable** for different sizes of Lids/Foodtainer
- **Flexible** lid positioning for different sizes of fruits or vegetables
- **Min. tray format**  
(L x W x H mm) 120 x 120 x 40
- **Max. tray format**  
(L x W x H mm) 260 x 130 x 40

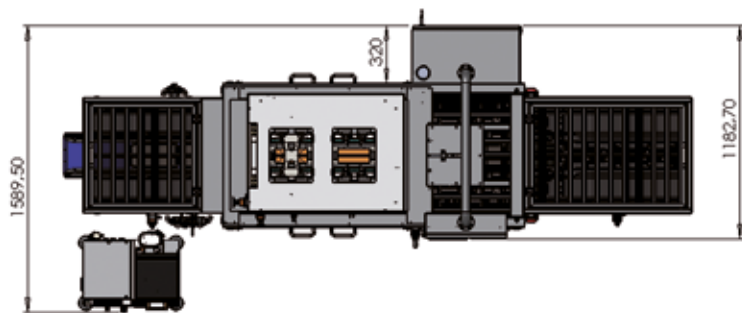
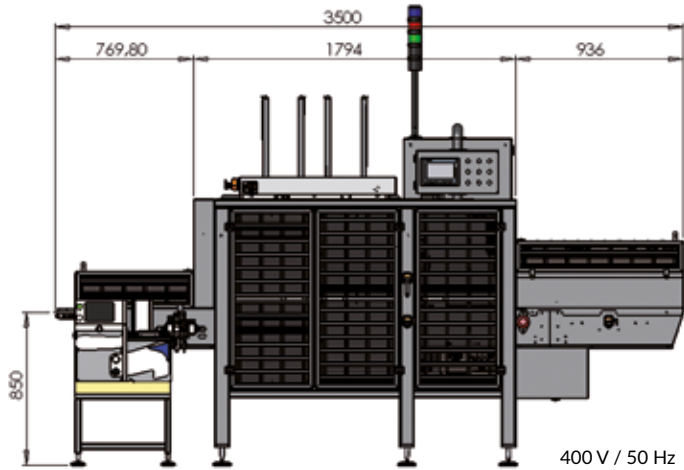

DE

## DIE „BLITZSCHALE“ – 100% NACHHALTIG

- Wellkarton klassisch, unbedruckt oder farbig bedruckt/ Fotodruck – Offset u/o Flexo - Digitaldruck
- Alternative in Graspapier (Anteil Grasfaser 40%)
- Schnelle Personalisierung des Deckeldesigns/Branding
- Maschine erlaubt schnelles Umrüsten auf andere Schalen/Deckelgrößen
- Plug & Play Möglichkeit vs. Dehnfolienmaschine

IT

## IL “VASSOIO BLITZ” - 100% SOSTENIBILE

- Cartone ondulato classico, neutro o stampato a più colori/ stampa foto – Offset e/o Flexo – stampa Digitale
- Alternativa in Carta Erba (percentuale fibra erba 40%)
- Personalizzazione veloce dei coperchi/Branding
- La macchina permette cambiamenti veloci per diverse misure di vassoi e coperchi
- Possibilità di Plug & Play vs. filmatrice

EN

## THE „BLITZ-TRAY“ - 100% SUSTAINABLE

- Classic corrugated cardboard, neutral or printed with different colours/print with photos – Offset and/or Flexo – Digital Printing
- Alternative in Grass Paper (percentage grass fibre 40%)
- Quick personalization of the lids/Branding
- The machine permits to change quickly different measures of trays and lids
- Possibility of Plug & Play vs. stretch machine